

inductive sensor

Bi10-G30SK-Y1X

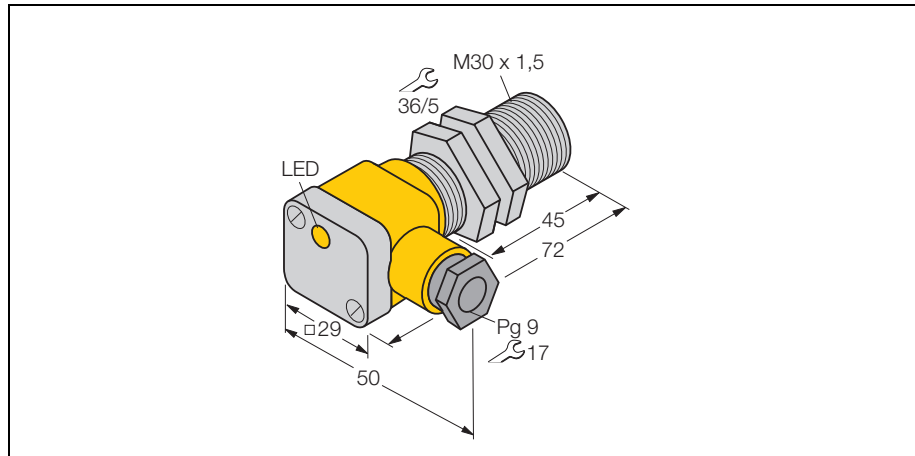

- ATEX category II 2 G, Ex Zone 1
- SIL2 according to IEC 61508
- threaded barrel, M30 x 1,5
- short version
- chrome-plated brass
- 2-wire DC, nom. 8.2 VDC
- output according to DIN EN 60947-5-6 (NAMUR)
- terminal chamber

Wiring diagram

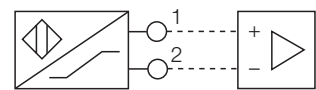

Function principle

Inductive sensors are designed for wear-free and non-contact detection of metal objects. For this they use a high-frequency electro-magnetic AC field that interacts with the target. With inductive sensors, this field is generated by an LC resonant circuit with a ferrite core coil.

Type	Bi10-G30SK-Y1X
Ident-No.	40220
Rated operating distance Sn	10 mm
Mounting condition	flush
Assured switching distance	≤ (0,81 x Sn) mm
Correction factors	St37 = 1, V2A ~ 0.7, Ms ~ 0.4, Al ~ 0.3
Repetition accuracy	≤ 2 %
Temperature drift	≤ ± 10 %
Hysteresis	1... 10 %
Ambient temperature	-25...+ 70 °C
Output function	2-wire, NAMUR
Switching frequency	≤ 0.5 kHz
Voltage	Nom. 8.2 V DC
Non-actuated current consumption	≥ 2.1 mA
Actuated current consumption	≤ 1.2 mA
Approval according to	KEMA 02 ATEX 1090X
Internal inductance(L _i) /Capacitance (C _i)	150 nF / 150 µH
Marking of the device	Ⓜ II 2 G EEx ia IIC T6 (max. U _i = 20 V, I _i = 20 mA, P _i = 200 mW)
Housing style	threaded barrel; M30 x 1,5
Dimensions	72mm
Housing material	metal, CuZn, chrome-plated
Material active area	plastic, PA12-GF30
Housing nut tightening torque	75 Nm
Connection	terminal chamber
Clamping ability	≤ 2.5 mm ²
Cable external diameter	4.5... 8 mm
Vibration resistance	55 Hz (1 mm)
Shock resistance	30g (11 ms)
Protection degree	IP67
Switch state display	LED yellow
Included in scope of supply	cable gland; 2x plastic seals

inductive sensor**Bi10-G30SK-Y1X**

Mounting instructions	minimum distances
Distance D	2 x B
Distance W	3 x Sn
Distance T	3 x B
Distance S	1,5 x B
Distance G	6 x Sn

Diameter of the active area B	Ø 30 mm
--------------------------------------	---------

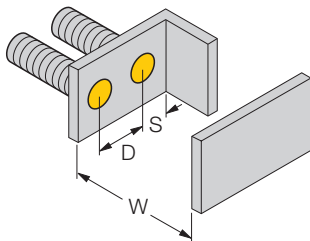
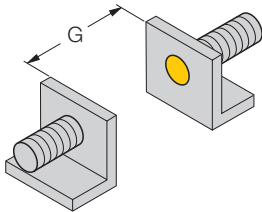
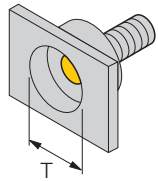

inductive sensor

Bi10-G30SK-Y1X

TURCK

Industrial
Automation

Accessories

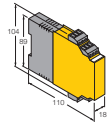
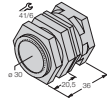
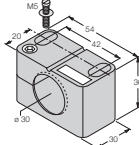
Type code	Ident-No.	Short text	Dimension drawing
IM1-22EX-R	7541231	isolating switching amplifier, two channels; input for NAMUR signals; optional wire-break and short-circuit monitoring function; selectable normally open or normally closed performance; removable terminal blocks; 18 mm wide; universal voltage supply unit	
QM-30	6945103	quick-mount fixing clamp with dead-stop; material: chrome-plated brass male thread M36 x 1.5. Note: The switching distance of proximity switches can be reduced by the use of quick mounting brackets.	
BST-30B	6947216	fixing clamp with dead-stop; material: PA6	

inductive sensor

Bi10-G30SK-Y1X

Operating manual

Intended usage

This device fulfils the directive 94/9/EC and is suited for use in explosion hazardous areas according to EN50014 and EN50020. Further it is suited for use in safety-related systems, including SIL2 to IEC 61508. In order to ensure correct operation to the intended purpose it is required to observe the national regulations and directives.

For use in explosion hazardous areas conform to classification

II 2 G (Group II, Category 2 G, electrical equipment for gaseous atmospheres).

Marking (see device or technical data sheet)

Ⓢ II 2 G and EEx ia IIC T6 to EN50020

Admissible ambient temperature at place of use

-25...+70 °C

Installation / commissioning

These devices may only be installed, connected and operated by trained and qualified staff. Qualified staff must have knowledge of protection classes, directives and regulations concerning electrical equipment designed for use in explosion hazardous areas, and, if necessary, of the regulations applicable to safety-related systems. Please verify that the classification and the marking on the device comply with the actual application conditions.

This device is only suited for connection to approved EExi circuits acc. to EN50014 and EN50020. Please observe the maximum admissible electrical values. After connection to other circuits the sensor may no longer be used in EExi installations. When interconnected to (associated) electrical equipment, it is required to perform the "Proof of intrinsic safety" (EN60079-14). When employed in safety systems to IEC 51408 it is required to assess the failure probability (PFD) of the complete circuitry.

Installation and mounting instructions

Avoid static charging of cables and plastic devices. Please only clean the device with a damp cloth. Do not install the device in a dust flow and avoid build-up of dust deposits on the device. If the devices and the cable could be subject to mechanical damage, they must be protected accordingly. They must also be shielded against strong electro-magnetic fields. The pin configuration and the electrical specifications can be taken from the device marking or the technical data sheet. In order to avoid contamination of the device, please remove possible blanking plugs of the cable glands or connectors only shortly before inserting the cable or opening the cable socket.

Repair / maintenance

Repairs are not possible. The approval expires if the device is repaired or modified by a person other than the manufacturer. The most important data from the approval are listed.